

Outdoor Temperature Humidity and Light Level Sensor

Descriptions

Outdoor weather station with humidity, temperature and light level sensors helps with free cooling strategies and other energy saving routines. The sensor communicates over both Ethernet and RS485, using BOTH Bacnet and Modbus protocols so there are many ways to integrate into the system. The modbus interface is documented and integrator friendly. They also have transducer outputs for connecting as analog inputs to all popular control systems.



Highlights

- Bacnet and Modbus over Ethernet: standard
- Bacnet and Modbus over RS485: standard
- Good long term stability and reliability
- 100% field changeable sensor, free calibration services
- Dew point and enthalpy are calculated and available over the com ports
- Durable ABS Plastic housing with UV protection additives

Specifications

General			
Power	15 to 24V AC or DC, ±10%		
Current Output Load	< 500Ω		
Display	LCD screen for wall outdoor / room mount and duct mount		
Display Resolution	0.1°C, 0.1% RH		
Temperature Limit	-30~60°C, 0~95% RH(Non condensing)		
Protection Degree	IP54		
	Relative Humidity	Temperature	Light
Sensor	Capacitance polymer	10K internal	TPS 851
Range	0~100% non condensing	-30~70°C(-22~158°F)	0~300lux
Output	4-20mA, 0-5V or 0-10V, RS 485	4-20mA, 0-5V or 0-10V, RS 485	
Accuracy	5% RH (25°C, 20~80% RH)	< ±0.5°C @ 25°C	5%
Hysteresis	< ±1% RH		
Response time	< 10s (25°C, in slow air)		
Drift	< ±0.5% RH / year		

Outdoor Temperature Humidity and Light Level Sensor

Note:

1. If you're using the 10V transducer output signal, the sensor needs to be powered with at least 15V AC or DC.
2. For application not using the 10V transducer output signal, using 4-20ma signal, 0-5V transducers, or Modbus/Ethernet only, in this case you can use 12V AC or DC.
3. Default network settings: RS485: Modbus protocol, baud rate 15200k, ID=254;
Ethernet: IP=192.168.0.34 , Bacnet and Modbus ID = 254

Dimensions

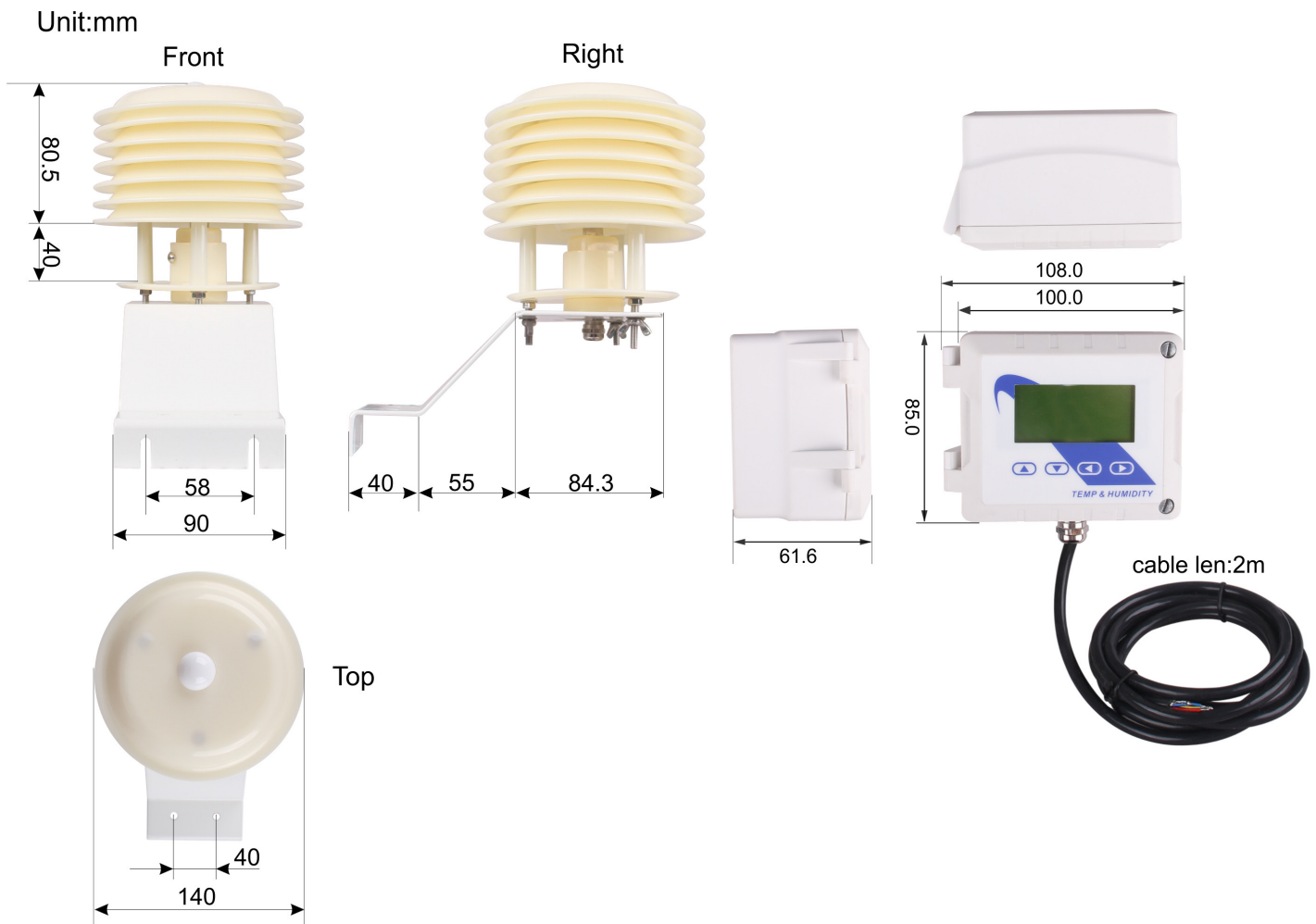

Outdoor Temperature Humidity and Light Level Sensor

Register List

Modbus

Humidity/Temp Transmitter w/Bacnet uses MODBUS protocol to communicate with others. Below is the register list.

Address	Register and Description
6	Address. Modbus device address
15	Baudrate. 0=9.6kbaud, 1=19.2kbaud 2=38.4kbaud 3=57.6kbaud 4=115.2kbaud
21	Protocol switch. 3 = MODBUS,0=Bacnet MSTP.
100	Room temperature reading in DegF. Can also write to this register for single point calibration.
373	Relative humidity reading in percentage, the same to register 304
482	Dew point in unit C
490	Enthalpy of the air, [kJ/kg]
538	Light sensor value. The resolution is 0.1 lux;

*For more register list details, please download an excel spreadsheet (ModbusBacnetRegisterList.xls) at the following link: <https://tinyurl.com/ybaj9d3u>.

Bacnet

Humidity/Temp Transmitter w/Bacnet also uses Bacnet protocol to communicate with others. Below is the register list.

Variable	Variable and Description
4	Modbus ID
8	Uart BaudRate. 0=9.6kbaud, 1=19.2kbaud 2=38.4kbaud 3=57.6kbaud 4=115.2kbaud
10	Protocol
12	Dew point
15	Enthalpy

Input	Input and Description
1	Temperature
2	Humidity
3	CO2
7	Light Value
Output	Output and Description
1	Analog output1
2	Analog output2

*For more register list details, please download an excel spreadsheet (ModbusBacnetRegisterList.xls) at the following link: <https://tinyurl.com/ybaj9d3u>.

Voltage & Current Formula for HUM (Hardware=Rev22+)	
0-10V output	Voltage = Temperature (C) / Temperature_Range * 10
	Voltage = Humidity / Humidity_Range * 10
0-5V output	Voltage = Temperature (C) / Temperature_Range * 5
	Voltage = Humidity / Humidity_Range * 5
4-20mA output	Current = Temperature (C) / Temperature_Range * 16 + 4
	Current = Humidity / Humidity_Range * 16 + 4

Outdoor Temperature Humidity and Light Level Sensor

Temperature (C): Register 101
 Humidity: Register 304
 Temperature_Range = (Register 286 - Register 285) / 10
 Humidity_Range = (Register 288 - Register 287) / 1000
 Voltage in V
 Current in mA

Wiring Diagram

The diagram below shows the wiring for the usual transducer mode of operation for the outdoor light/temp/hum sensor. The transducer outputs connect to a master controller using the traditional analog output signals, 0-5V, 0-10V, 4-20mA.

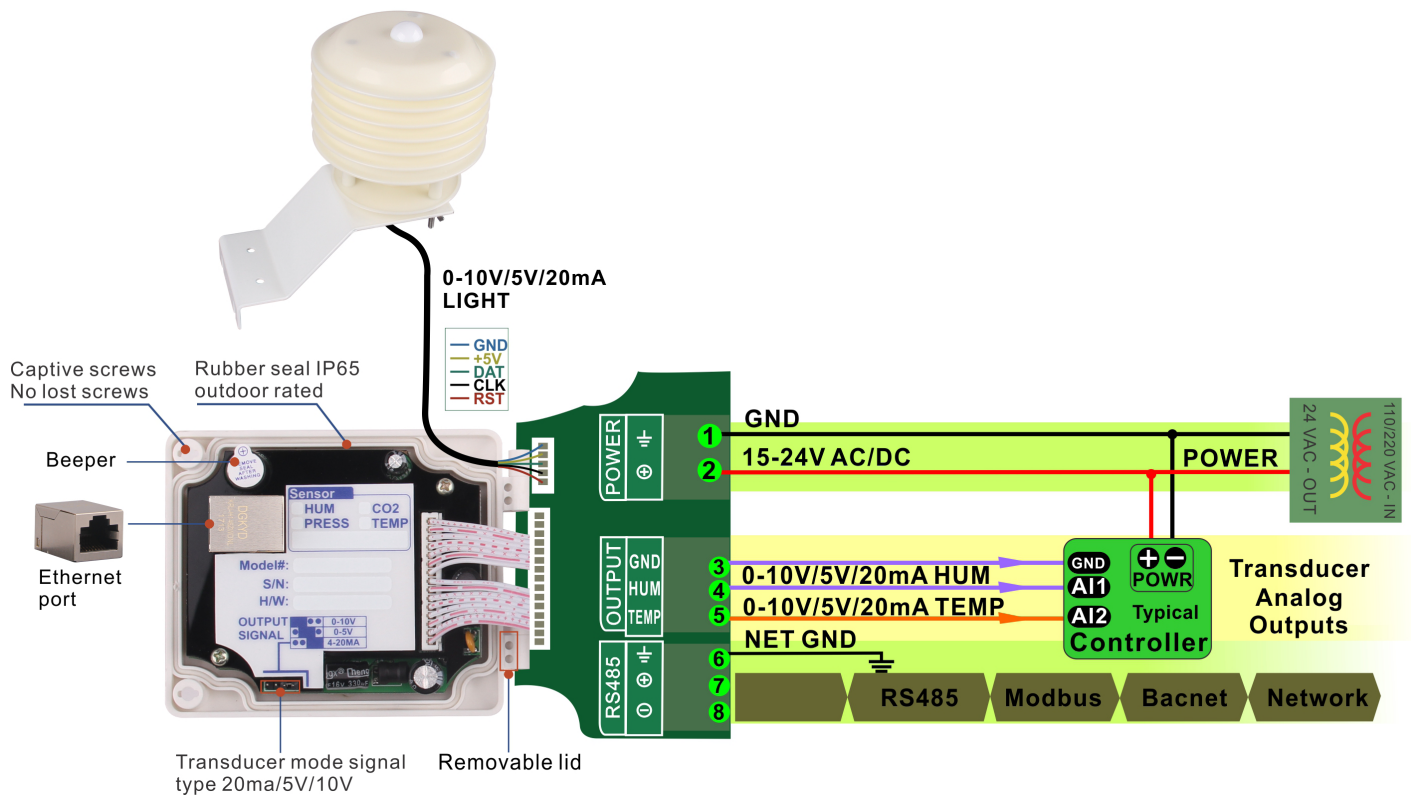

Output Jumper Settings

In this mode the device acts as a traditional transducer where it sends out three analog signals, all you need to do is to set this one single jumper to the appropriate signal type: 4-20mA, 0-10V, or 0-5V.

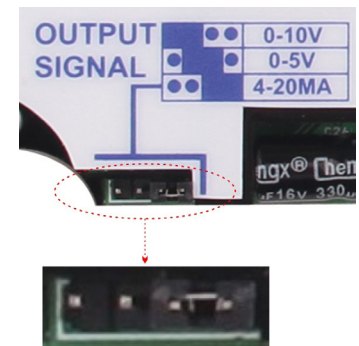

Outdoor Temperature Humidity and Light Level Sensor

Mounting Installation

Step1. Install mounting screw1 to mounting hole1 as below.

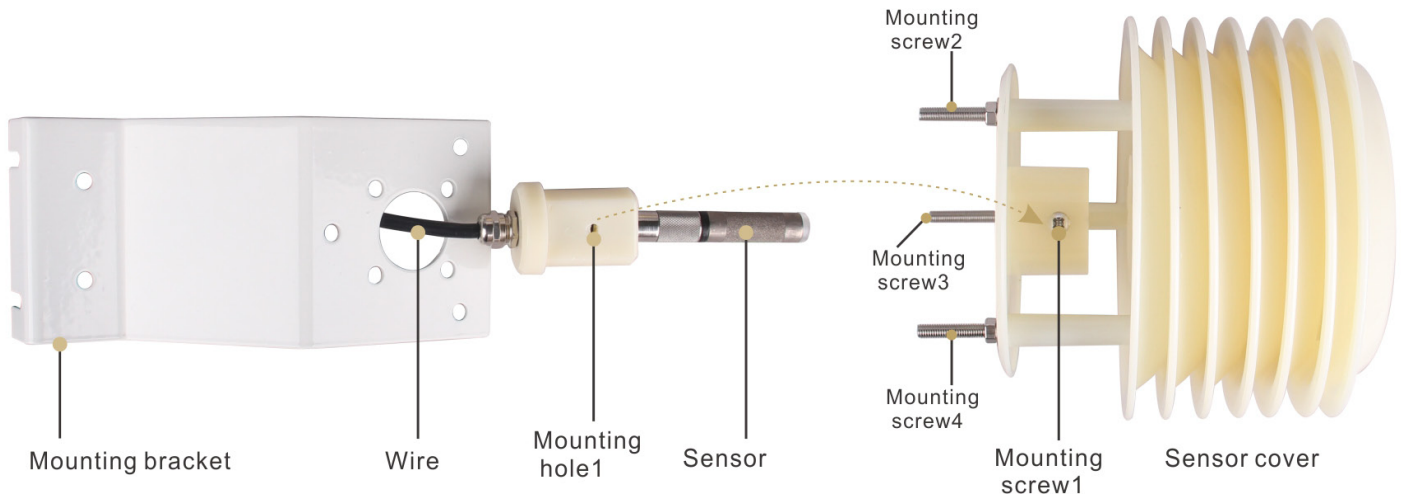

Step2. Install mounting screw2,3,4 to mounting hole2,3,4 as below.

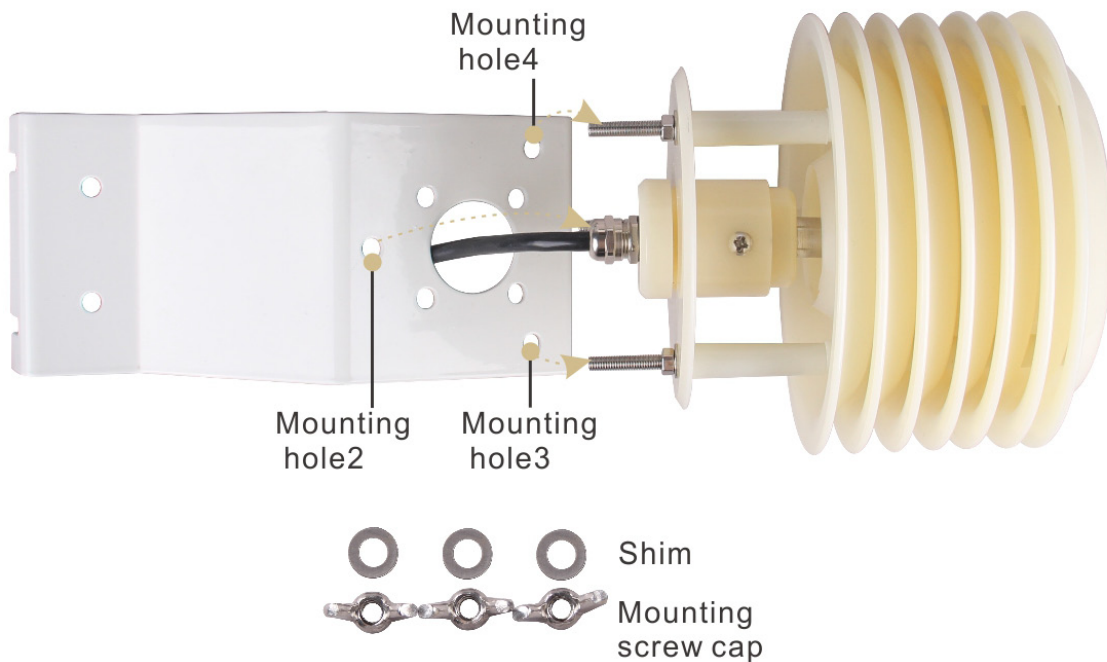

Outdoor Temperature Humidity and Light Level Sensor

Step3. Then install the shims and mounting scw caps. The installation is finished as below:



Outdoor Temperature Humidity and Light Level Sensor

**How to use a bigger gland for ethernet connectors*

Using a bigger gland for ethernet connectors can make it easier for ethernet cables to enter. Below are the steps:

1. You need to use a electric drill to make the entrance bigger.



2. Then let the ethernet cable enter through the gland.

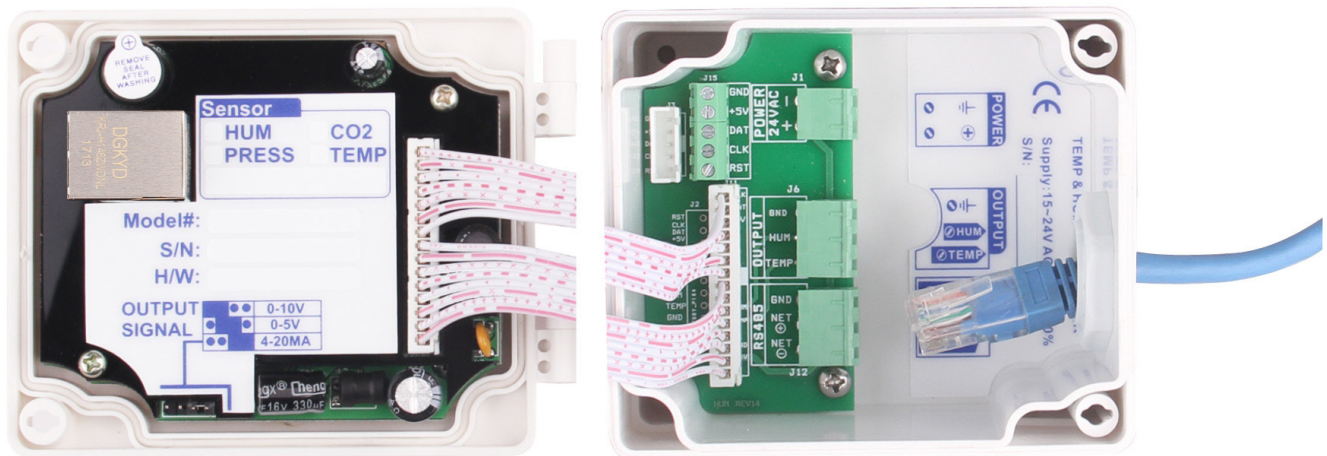

Outdoor Temperature Humidity and Light Level Sensor

T3000 Operation

1. Connect to PC by RS485.
2. Open T3000 and it show the following view.

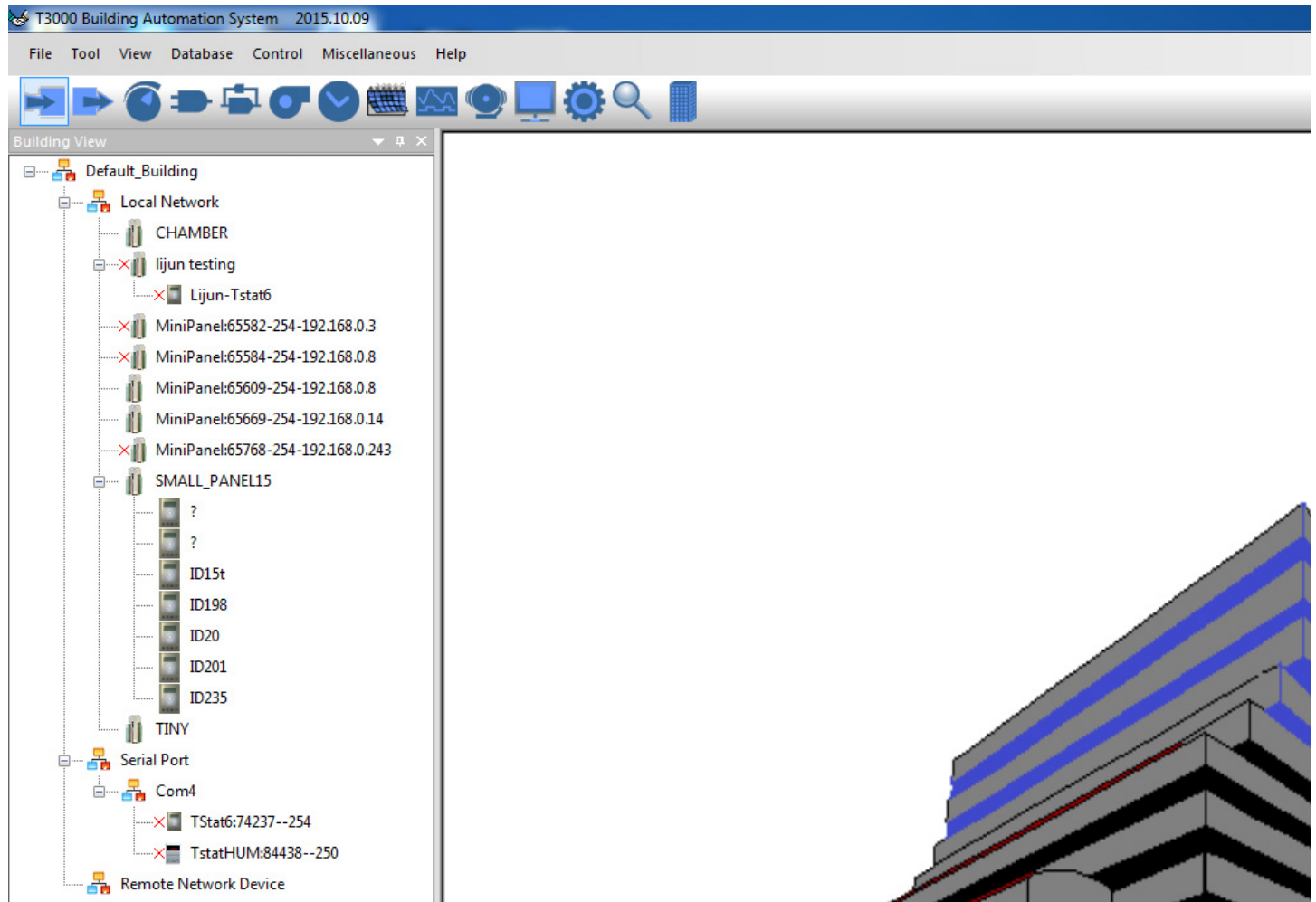

Outdoor Temperature Humidity and Light Level Sensor

3. Click the button to scan, the following view will appear and close it as the picture shows.

Step 1: Click here to scan

Step 2: Click here to close

HUM sensor connected

Model	Building	Floor	Room	Sub_net	Serial#	Address	Port	Protocol
BB/LB/T3-65550-1-192.168.0	fault_Buildi	floor1	room1	fault_Buildi	65550	192.168.0.14	502	TCP/IP
BB/LB/T3-90023-1-192.168.0	fault_Buildi	floor1	room1	fault_Buildi	90023	192.168.0.15	502	TCP/IP
JWIFI-3333-125-192.168.0.14	fault_Buildi	floor1	room1	fault_Buildi	33333	192.168.0.14	502	TCP/IP
WIFI-6342-11-192.168.0.14	fault_Buildi	floor1	room1	fault_Buildi	96342	192.168.0.14	502	TCP/IP
T3-4A-85342-3-192.168.0.14	fault_Buildi	floor1	room1	fault_Buildi	85342	192.168.0.14	502	TCP/IP
W-6411-10-192.168.0.14	fault_Buildi	floor1	room1	fault_Buildi	96411	192.168.0.14	502	TCP/IP
B/L/T3-92468-254-192.168.0	fault_Buildi	floor1	room1	fault_Buildi	92468	192.168.0.244	10000	TCP/IP
HUM:2883884-250-192.168.0	fault_Buildi	floor1	room1	fault_Buildi	2883884	192.168.0.244	10000	TCP/IP

4. Click the HUM log and it will show all the information.

In input setting view, there are temperature, humidity and dew point. In output setting view, when you click the humidity, an arrow appears, you can choose humidity or dew point.

Step 3: Click the logo

Table appears

Selectable

NUM	Full Label	Auto/Manual	Value	Range	Calibration	Filter
1	Temperature	Auto	28.5	°C	-1717986918	
2	Humidity	Auto	48.1	%	858993459	

NUM	Full Label	Value	Range	Min Out Scale	Max Out Scale	Auto/Manual
1	Temper...	5.85 v	0-10v	-30.0	70.0	Auto
2	Humidit	4.8%	0-10%	0	100	Auto
3	Dew Point					

NUM	Full Label	Auto/Manual	Value	Range	Calibration
1	Dew Point	N/A	16.6	°C	N/A
2	Partial Pressure	N/A	18.9	hPa	N/A
3	Mixing Ratio	N/A	11.8	g/Kg	N/A
4	Enthalpy	N/A	59.1	KJ/kg	N/A

Outdoor Temperature Humidity and Light Level Sensor

T3000 calibration

The picture shows T3000 calibration of HUM.Do as the follows:

You can click to change value or calibration,also to choose User Table or Factory Table:

The screenshot displays the T3000 Building Automation System interface. The left sidebar shows a tree view of the building structure, with 'HUMSENSOR' highlighted under the 'CHAMBER' section. The main window shows the 'System Parameters' for the selected sensor, including Address (250), Serial number (2883884), Model (HUM Sensor), Firmware Version (37.5), Hardware Version (0), and Baudrate (19200). Below this, the 'INPUT Setting' table is visible, with red boxes around the 'Value' (30.3) and 'Calibration' (2.2) columns. Red arrows point to these boxes with the text 'Click here to change value' and 'Click here to change Calibration'. The 'OUTPUT Setting' table shows two rows for Temperature and Humidity. The 'Variables' table at the bottom is partially obscured by a red box and an arrow pointing to a scroll bar, with the text 'Scroll this to right to show table below'.

NUM	Full Label	Auto/Manual	Value	Range	Calibration	Filter
1	Temperature	Auto	30.3	°C	2.2	0
2	Humidity	Auto	81.2	%	0.0	0

NUM	Full Label	Value	Range	Min Out Scale	Max Out Scale	Auto/Manual
1	Temper...	6.03 v	0-10v	-30.0	70.0	Auto
2	Humidity	8.12v	0-10v	0	100	Auto
3						

NUM	Full Label	Auto/Manual	Value	Range	Calibration
1	Dew Point	N/A	26.7	°C	N/A
2	Partial Pressure	N/A	35.0	hPa	N/A
3	Mixing Ratio	N/A	22.2	g/Kg	N/A
4	Enthalpy	N/A	87.6	KJ/kg	N/A

Outdoor Temperature Humidity and Light Level Sensor

The screenshot displays a software interface for configuring a HUMSENSOR. The top section shows sensor details: Serial number 2883884, Model HUM Sensor, Hardware Version 0, and Baudrate 19200. A 'Factory Reset' button is visible on the right. Below this is a table for sensor calibration:

Range	Calibration	Filter
°C	2.2	0
%	0.0	0

A 'Calibration Table' button is highlighted with a red box and the text 'Click here'. Below the main interface, a 'Graphic Mode' window is shown, containing a graph of Humidity (%) vs. Frequency/Hz and two tables: 'User Table' and 'Factory Table'. The 'User Table' has one entry:

NUM	Frequency	Humidity(%)
1	0	0.0

The 'Factory Table' contains five entries:

NUM	Frequency	Humidity(%)
1	8858	43.5
2	8910	48.9
3	9007	57.2
4	9132	66.0
5	9268	76.8

The graph plots these data points, showing a linear relationship between Frequency/Hz and Humidity(%). Red annotations include 'Click here to choose User Table' pointing to the 'User Table' header, 'Click here to add NUM' pointing to the 'Add' button, and 'Click here to choose Factory Table' pointing to the 'Factory Table' header. The text 'Show a table' is also present near the graph area.

Outdoor Temperature Humidity and Light Level Sensor

Modbus Register List

Address	Register and Description
0 to 3	Serial Number -4 byte value. Read-only
4 to 5	Software Version –2 byte value. Read-only
6	ADDRESS. Modbus device address
7	Product Model. This is a read-only register that is used by the microcontroller to determine the product
8	Hardware Revision. This is a read-only register that is used by the microcontroller to determine the hardware Rev
9	PIC firmware version
10	'Plug n Play' address, used by the network master to resolve address conflicts. See VC code for algorithms
15	Bau - Baudrate, 0=9.6kbaud, 1=19.2kbaud 2=38.4kbaud 3=57.6kbaud 4=115.2kbaud
16	Firmware Update Register, used to show the status of firmware updates
21	Protocol switch. 3 = MODBUS,0=MSTP.
17-39	Blank, for future use
40 to 45	reg40, MAC address, read only normally
46	reg46, IP mode. 0=static IP; 1= DHCP
47 to 48	reg47, upper two bytes of IP address
49 to 50	reg49, lower two bytes of IP address
51 to 52	reg51, right two bytes of SUBNET MASK address
53 to 54	reg53, left two bytes of SUBNET MASK address
55 to 56	reg55, right two bytes of GATEWAY address
57 to 58	reg57, left two bytes of GATEWAY address
59	reg59, 0, TCP server, (NO USE)
60	reg60, listen port at TCP server mode
61~75	buffer mirror for changing to a new IP address, copy of reg 46 to 60
76	write 1 to set the ghost settings to the system and start new settings, then clear the ghost registers.
93	Enable for MAC setting. It should be set as 1 before write the new MAC to the MAC registers(100-105), and it will be cleared automatically after setting the MAC address.
100	ROOM TEMPERATURE reading in DegF. Can also write to this register for single point calibration.
101	ROOM TEMPERATURE reading in DegC. Can also write to this register for single point calibration.
113	Not used
121	LCD temperature will show C or F, 0 =C, 1=F

Outdoor Temperature Humidity and Light Level Sensor

Modbus Register List

Address	Register and Description
185	Bau - Baudrate, 0=9600, 1=19.2k baud
186	The factory default is 1. Temperature Transducer output range, 1=0-10V, 2=0-5V, 3=4-20mA
187	The factory default is 1. Humidity Transducer output range, 1=0-10V, 2=0-5V, 3=4-20mA
285	The minimum degree of temperature range corresponding to the temperature output
286	the maximum degree of temperature range corresponding to the temperature output
287	the minimum percent of humidity range corresponding to the humidity output
288	the maximum percent of humidity range corresponding to the humidity output
304	Relative Humidity reading. Writing a humidity value to the register will do calibration, for details, refer to Humidity Calibration.
370	Auto/Manual output calibrate set. 0 : default value 1 : user manual. Bit 0 :temperture bit1 :humidity
371	Temperature manual output value input, releative with register 370
372	Humidity manual output value input, releative with register 370
373	Relative humidity in percentage,the same to register304
374	sensor frequency on time
375~380	spare for futher function
381	Factory 1st Calibration point. RH
382	Factory 1st Calibration point. Frequency
383	Factory 2nd Calibration point. RH
384	Factory 2nd Calibration point. Frequency
385	Factory 3rd Calibration point. RH
386	Factory 3rd Calibration point. Frequency
387	Factory 4th Calibration point. RH
388	Factory 4th Calibration point. Frequency
389	Factory 5th Calibration point. RH
390	Factory 5th Calibration point. Frequency
391	Factory 6tht Calibration point. RH
392	Factory 6th Calibration point. Frequency
393	Factory 7th Calibration point. RH
394	Factory 7th Calibration point. Frequency
395	Factory 8th Calibration point. RH
396	Factory 8th Calibration point. Frequency
397	Factory 9th Calibration point. RH
398	Factory 9th Calibration point. Frequency
399	Factory 10th Calibration point. RH

Outdoor Temperature Humidity and Light Level Sensor

Modbus Register List

Address	Register and Description
400	Factory 10th Calibration point. Frequency
450	Temperature Calibration Offset for sensor
451	Humidity Calibration Offset for sensor
452	the filter of temperature
453	the filter of humidity
454	calibrate table select,default tabel =0 or customer table = 1
455	user calibrate points number
456 ~ 475	user calibrate points
476	K line
477	B line
478	humidity sensor serial number
479	spare for futher function
480	spare for futher function
481	spare for futher function
482	dew point in unit c
483	dew point in unit F
484	heat control
485	spare for futher function
486	dewpoint output min range
487	dewpoint output max range
488	Partial Pressure of water at saturation at given temperature, [hPa]
489	Mixing Ratio, the mass of water over the mass of dry gas, [g/kg]
490	Enthalpy of the air, [kJ/kg]
491	Modbus reply delay time (ms)
492	Modbus receive delay time(ms)
500	PID1 MODE: 0=COOL MODE,1=HEAT MODE
501	PID1 SetPoint
502	PID1 Pterm
503	PID1 Iterm
504	PID1 Value
510	PID2 MODE:0=COOL MODE,1=HEAT MODE
511	PID2 SetPoint
512	PID2 Pterm
513	PID2 Iterm
514	PID2 Value
536	The light sensor filter
538	The light sensor value .The resolution is 0.1 lux

Outdoor Temperature Humidity and Light Level Sensor

Bacnet Register List

Variable	Variable and Description
0	Spare
1	SerialNumber LowByte
2	SerialNumber HighByte
4	ID Address
5	Product Model
6	Instance
7	Station number
8	Uart BaudRate.0=9.6kbaud, 1=19.2kbaud 2=38.4kbaud 3=57.6kbaud 4=115.2kbaud
9	Update
10	Protocol
11	Auto/Manual
12	Dew point
13	Pws
14	MixRatio
15	Enthalpy
16	OffSet Humdity
17	OffSet Tempeature
18	OffSet CO2
19~21	spare
22	Filter Humdity
23	Filter Temperature
24	Filter CO2
25~27	Spare
28	Temperature Unit .0 = C, 1 =F
29	OutMode. 1=0-10V, 2=0-5V, 3=4-20mA
30	Output1 Min Range
31	Output1 Max Range
32	Output2 Min Range
33	Output2 Max Range
34	Output3 Min Range
35	Output3 Max Range

Outdoor Temperature Humidity and Light Level Sensor

Bacnet Object List

Input	Input and Description
1	Temperature
2	Humidity
3	CO2
7	Light Value
Output	Output and Description
1	Analog output1
2	Analog output2
3	Analog output3

Outdoor Temperature Humidity and Light Level Sensor

Analog Value

To check the analog value, you can use a software "Yet Another Bacnet Explorer-Yabe". Below are the steps to get the analog value.

Step1: Download the software "Yet Another Bacnet Explorer-Yabe" and install it.

Step2: Plug the sensor in power, connect it to your PC via RS485 or Ethernet.

Step3: Click the item you want to check, a table reads BacnetProperty will pop-up on the right.

The screenshot shows the 'Yet Another Bacnet Explorer - Yabe' software interface. The 'Devices' tree on the left is expanded to show a list of devices under 'Vdp: 47808'. A red box highlights the 'Humidity [1638435]' device. The 'Address Space' tree below it is also expanded, showing various properties like 'ANALOG_INPUT', 'ANALOG_OUTPUT', and 'ANALOG_VALUE'. A red box highlights the 'SN_L' property under 'ANALOG_VALUE'. The 'Properties' pane on the right shows the details for the selected 'BacnetProperty', including Event State, Object Identifier, Object Name, Object Type, Out Of Service, Present Value, and Status Flags.

Device	ObjectId	Name	Value	Time	S
192.168.0.124	47808	5951			
192.168.0.200	47808	90049			
192.168.0.15	47808	90023			
192.168.0.33	47808	33073			
192.168.0.209	47808	99605			
192.168.0.144	47808	144			
192.168.0.140	47808	65536			
192.168.0.105	47808	10557			
192.168.0.244	47808	92468			

Property	Value
Event State	0 : Normal
Object Identifier	OBJECT_ANALOG_VALUE:1
Object Name	SN_L
Object Type	2 : Object Analog Value
Out Of Service	False
Present Value	31264
Status Flags	0000

BacnetProperty	
Event State	0 : Normal
Object Identifier	OBJECT_ANALOG_VALUE:1
Object Name	SN_L
Object Type	2 : Object Analog Value
Out Of Service	False
Present Value	31264
Status Flags	0000